

VOLANTINI e LOCANDINE

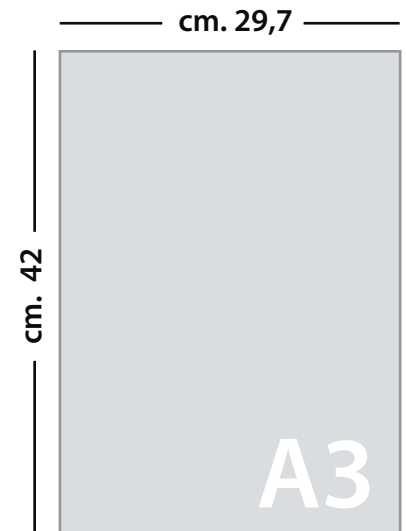

BIGLIETTI DA VISITA (scala 1:1)

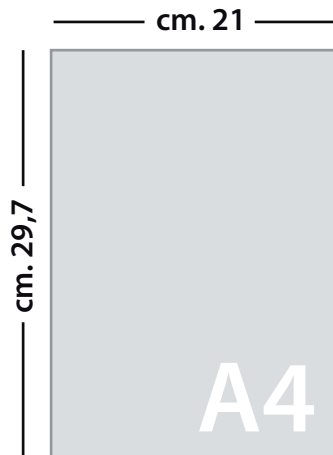
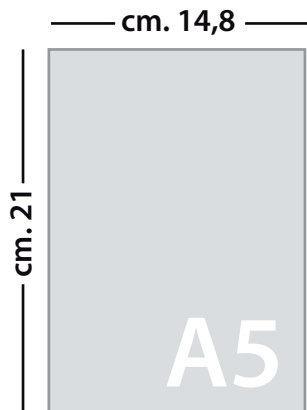
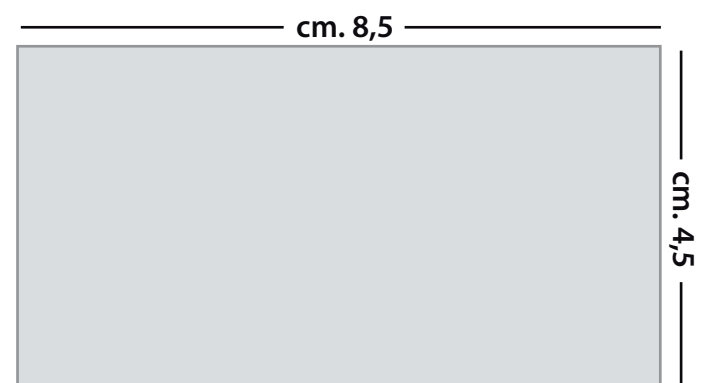
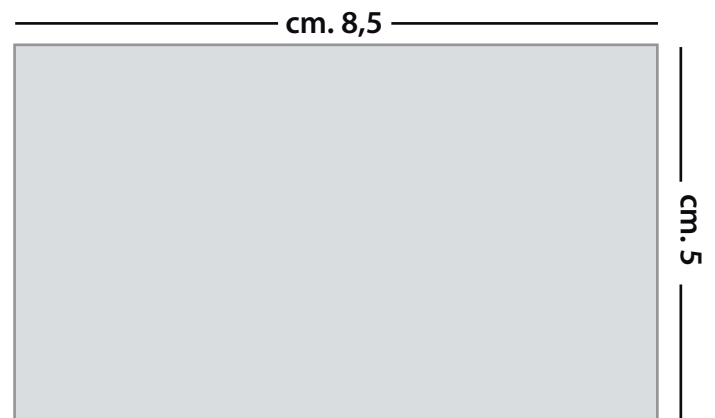
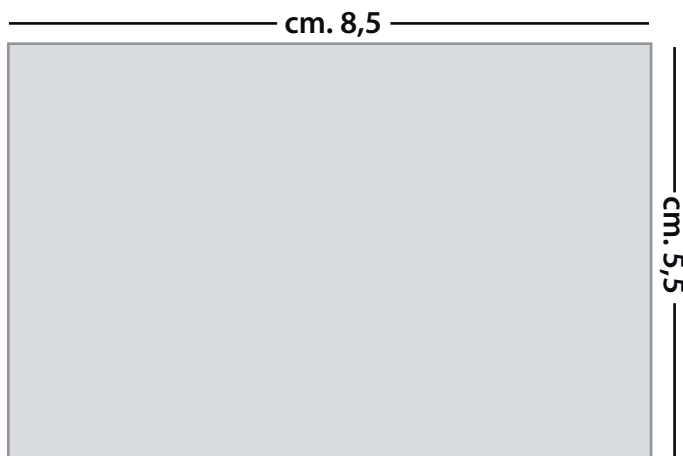

DEPLIANT

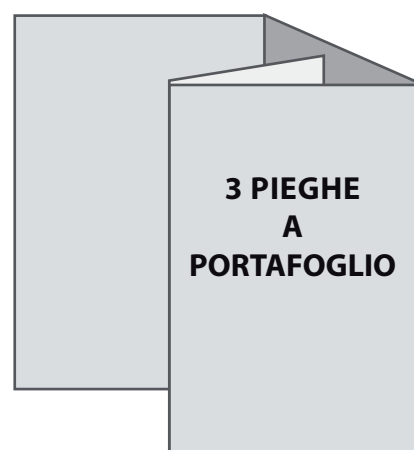
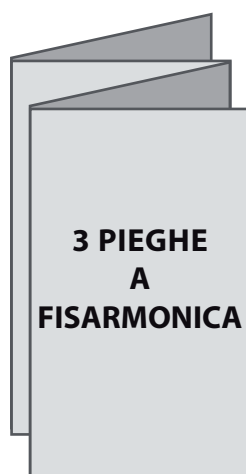
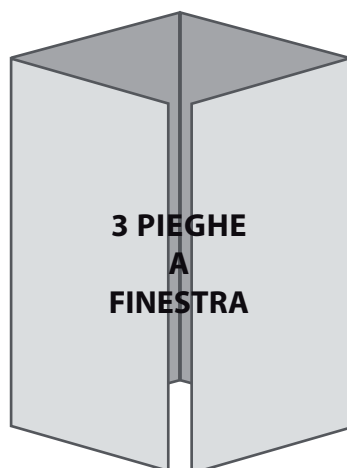
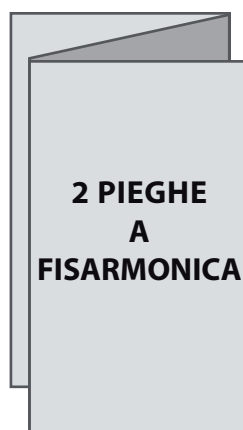

PIEGHEVOLI

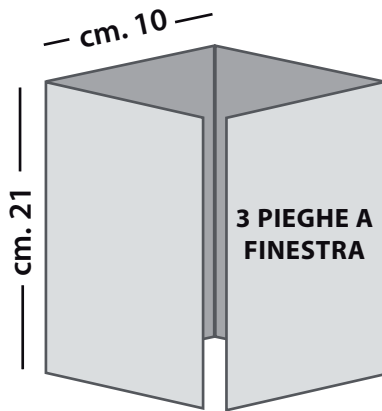

formato aperto cm. 40x21

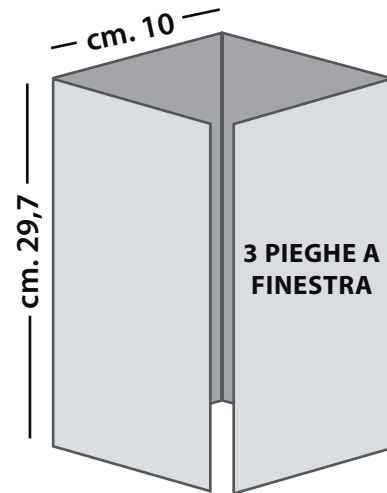

formato aperto cm. 41,5x29,7

CARTELLETTE

